

STAINLESS STEEL BIKE DOCK



Luxurious and graceful, our stainless-steel bike rack offers architectural elegance to any project. Design offers multiple installation options that can add style and beauty to your bike parking or overall building project. Meets all APBP bike parking standards and is quite attractive in the process.

Product Specifications

- 2.375", schedule 40, 304 stainless steel pipe
- Brushed finish
- Accommodates two bikes
- Offers 2 points of contact for bike stability
- Meets APBP bike parking guidelines

Stainless Steel Bike Dock

Recommended Setbacks

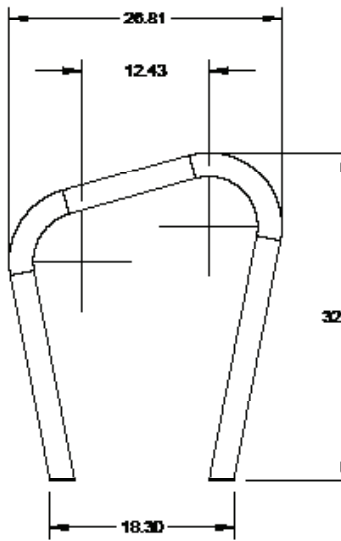
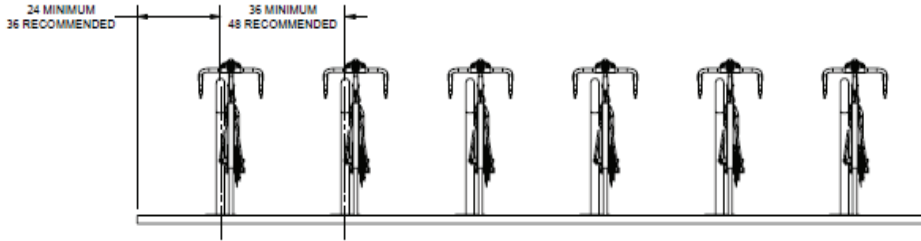
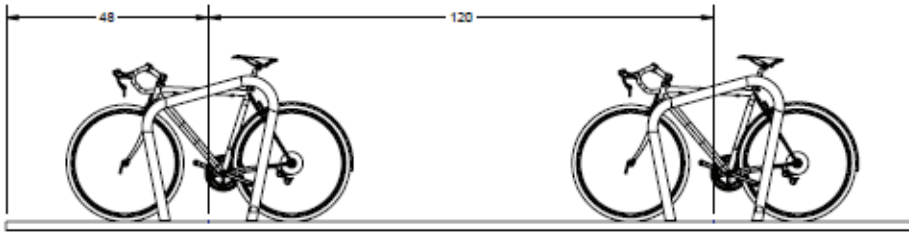

27966 Shown

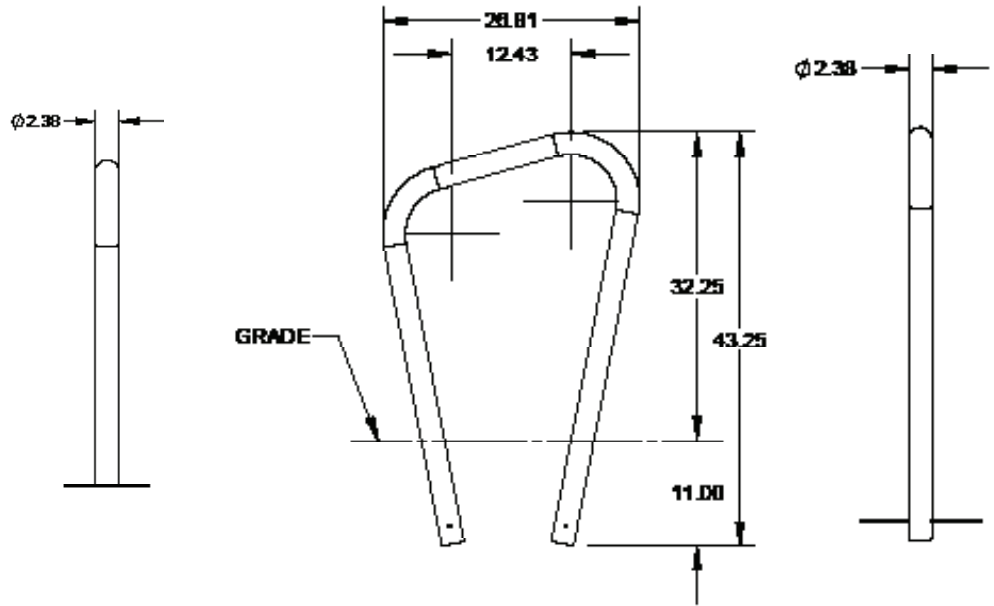

2 bikes



2.375", Schedule 40,
304 Stainless Steel
Pipe



Brushed



Temporary: 6264
(install kit: 25683)
Temporary
Secure: 6260
(install kit: 26268)
Permanent: 6265



1 year
warranty



Made in
the USA

Anchors must be purchased separately



Standard Colors



Flange Mount



Below Grade
Mount

Dimensions

Model #	# Bikes	Type of Mount	Weight	Length	Height	Width
27966	2	Flange	24lbs.	26.81"	32.25"	2.38"
28363	2	Below Grade	35 lbs.	26.81"	43.25"	2.38"

Downloadable product resources available online:



CAD Files



SketchUp Files



Written Specs



Photos

Our Saris Infrastructure representatives can assist with custom layout and spacing to meet your room dimensions and desired bike capacity.

Saris Infrastructure 800.783.7257

www.sarisinfrastructure.com