

NOTES:

1. DO NOT SCALE DRAWING.
2. INSTALLATION TO BE COMPLETED IN ACCORDANCE WITH MANUFACTURER'S SPECIFICATIONS.
3. TOTAL WEIGHT: 138.32 LBS

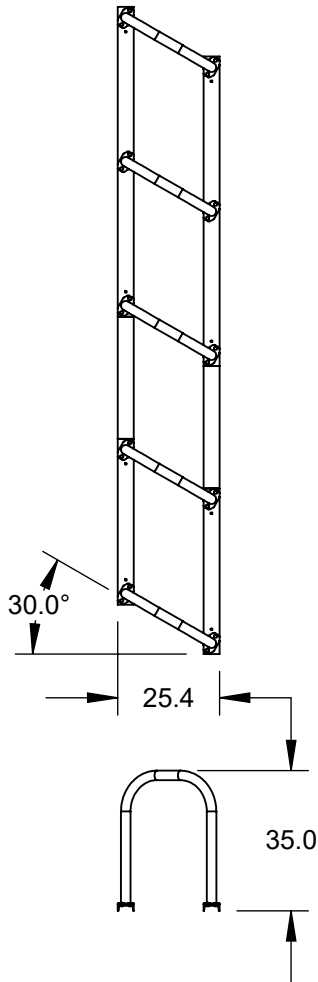

ANGLED CONFIGURATION

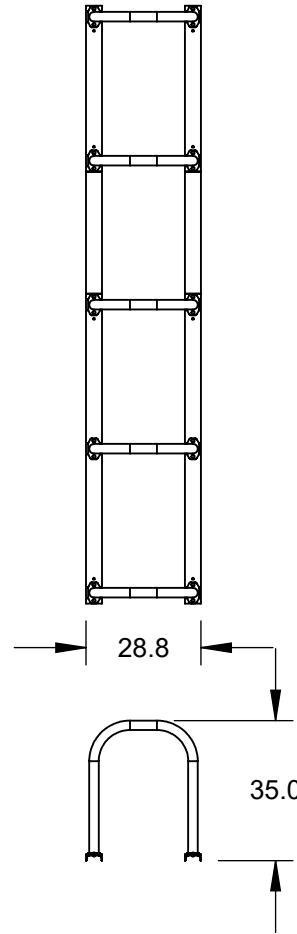
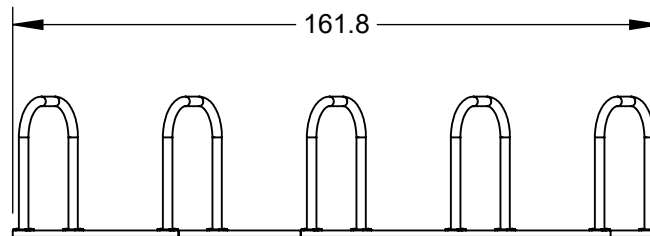

STRAIGHT CONFIGURATION

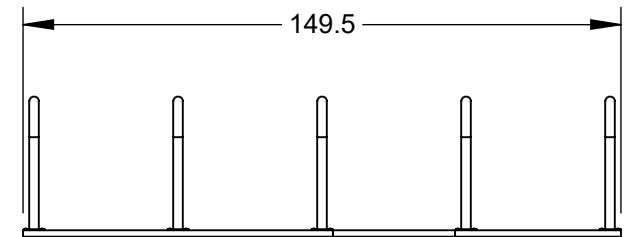

5253 VERONA ROAD, MADISON WI. 53711
1-800-783-7257 / WWW.SARIS.COM

© SARIS CYCLING GROUP 2014
THE INFORMATION CONTAINED IN THIS DRAWING IS THE SOLE CONFIDENTIAL PROPERTY OF
SARIS CYCLING GROUP ANY REPRODUCTION IN PART OR WHOLE WITHOUT
THE WRITTEN PERMISSION OF SARIS CYCLING GROUP IS PROHIBITED.

TITLE:

10 BIKE CORRAL